



SMART PUSH PULL DOORLOCK

MI-7800

USER MANUAL



Free Direction
Push-Pull Handle



Smart Auto
Safety function



Voice Guide



Status Checking
Guide



Trespass Alarm
Function



Wireless Interlock
Function
(only MI-7000T)

Notice

Please receive the entry certainly and get introduction from installing store and its installer. If there is no exact entry on warranty form, you should be disadvantaged on A/S. The function and design will be changed without notice to improve the performance.

Thank you for purchasing this product.

Please use properly after reading this instruction carefully.

Safety precautions



Do not disassemble or alter the lock. Assembling or disassembling the doorlock may damage the product. Damages to the product caused by unauthorized persons may result in damages to your property. Please contact our Customer Service.



If the product generates harmful gases or smoke, please remove the batteries immediately from the product. If you do not take this step immediately, the product may suffer severe damage.



Please keep the product away from water or any liquids. If the product is exposed to salty water or liquids, please wipe off the moisture with a soft cloth. If moisture or foreign materials penetrate the product, remove the batteries immediately and contact the Service Agency or Customer Service Center for advice. Using a product contaminated with foreign materials may cause problems.



Please check the batteries every 6 months to see if the batteries are leaking and to check the cleanliness of battery terminals. If leakage is discovered, please wipe out with a dry cloth and replace the new batteries. In case of exposure to leakage, wash with soap and water immediately.



Do not clean the product with flammable materials such as alcohol, benzene or thinners. Such materials may damage the surface or cause a fire.



Batteries should not be exposed directly to heat sources or flames, or submerged in water, because they may leak or explode, resulting in severe damage. Please do not use damaged batteries.



Do not allow the battery electrodes to make contact with metals such as keys, as the battery may overheat, causing explosion or severe damage.



Please do not close the door with the deadbolt in the locked position. It may damage the product or cause a malfunction.



Do not force to pull the front cover. It may damage the product or cause a malfunction.



Please do not mix old with new batteries or use different types. Always use new alkaline batteries. Please make sure the batteries are inserted correctly (+/-) as indicated in the battery compartment. Otherwise, it may cause a leak or explosions.



Please do not hang the heavy things or bag, etc on the handle. It may damage the handle or cause a malfunction

Contents

I . Before using	Product features	04
	Product composition and components	06
	Name and function of each part	08
	Description shortcut icons.....	10
	How to replace battery	10
	How to apply external power in the emergency	10
	How to use mechanical override key.....	10
	How to use random security coding function	10
<hr/>		
II . Basic function	How to unlock / to lock from outdoor.....	11
	How to set auto-locking/manual-locking	11
	How to select the language.....	11
	How to unlock / to lock from indoor	11
	How to set double locking function.....	12
	Safety handle function.....	12
	Auto-locking function / Auto-relocking function.....	12
<hr/>		
III . Normal Mode & Safety Mode	How to change normal mode / safety mode.....	13
	How to register / to delete the secret code in normal mode	13
	How to register / to delete the card key in normal mode.....	13
	How to register / to delete the finger print in normal mode.....	13
	How to register / to delete the secret code in safety mode.....	14
	How to register / to delete the card key in safety mode	14
	How to register / to delete the finger print in safety mode.....	14
	To change manage code in safety mode.....	14
	To register manager card in safety mode.....	14
	To delete all manager card in safety mode.....	14
<hr/>		
IV . Applications	How to control voice guide volume	15
	Guest secret code (Temporary use)	15
	How to control operation volume.....	15
	Status checking guide	15
	Check battery capacity	15
	Safety handle function.....	15
	Warning function against mischief or hacking	15
	Warning alarm function against trespassing by force	15
	How to install the communication pack	16
	How to register / to delete remote key & to unlock / to lock	16
<hr/>		
V . Others	Simplified Chinese characters	18
	Traditional Chinese characters	33
	Product Warranty.....	47

Product features



Convenient Push ↔ Pull Handle Convert Function

Direction of push and pull may be freely adjusted according to the door opening direction.



Smart Auto Safety Handle

Operation of the handle inside is restricted for preventing outside intrusion.



Bi-direction Installation Method : Motorized Mortise Lock

The mortise of this product is convenient for installing as left/right direction is adjustable.



A↔M Automatic/Manual Locking Set Function

Automatic and manual locking mode set is possible with simple switch operation from inside.



Auto-relock function

If users do not open the door after unlocking, it is to be locked automatically for higher security



Double lock function

When double lock function is activated, the door cannot be opened from outside even with the registered card, secret code or finger print. (only override key)



Mute function

You can open the door in quite not to interrupt neighbor without any operating sound temporarily.



Battery level indicator & alarm for battery replacement time

Easy to check battery status with 3 step level indicator and alarming battery replacement time with sound & lamp



Trespass alarm function

When the door is opened by force with hammer or other lock is suspended with alarm sound



Prevent mischief & hacking

With applying wrong code 3 times, unregistered card for 3 times or unregistered finger print for 5 times, alarm system is activated with warning sound and all the function of door lock is suspended for 3 minutes.



Random security coding function

When you enter your home with friends or other people, you don't want to show secret code to them. In his case, you may press any number randomly without limitation and then enter your secret code at final. Then, you can open the door without revealing your secret code.



Normal mode / Security mode

Normal mode : Easy to use for normal user

Safety Mode : High security mode with manager function added, provides individual register and delete function which is not provided in normal mode.



Option Function

Option button : To use for register or setting change of optional functions.

1. Register and setting for RF connection option
2. Change setting of Language option

Product composition and components

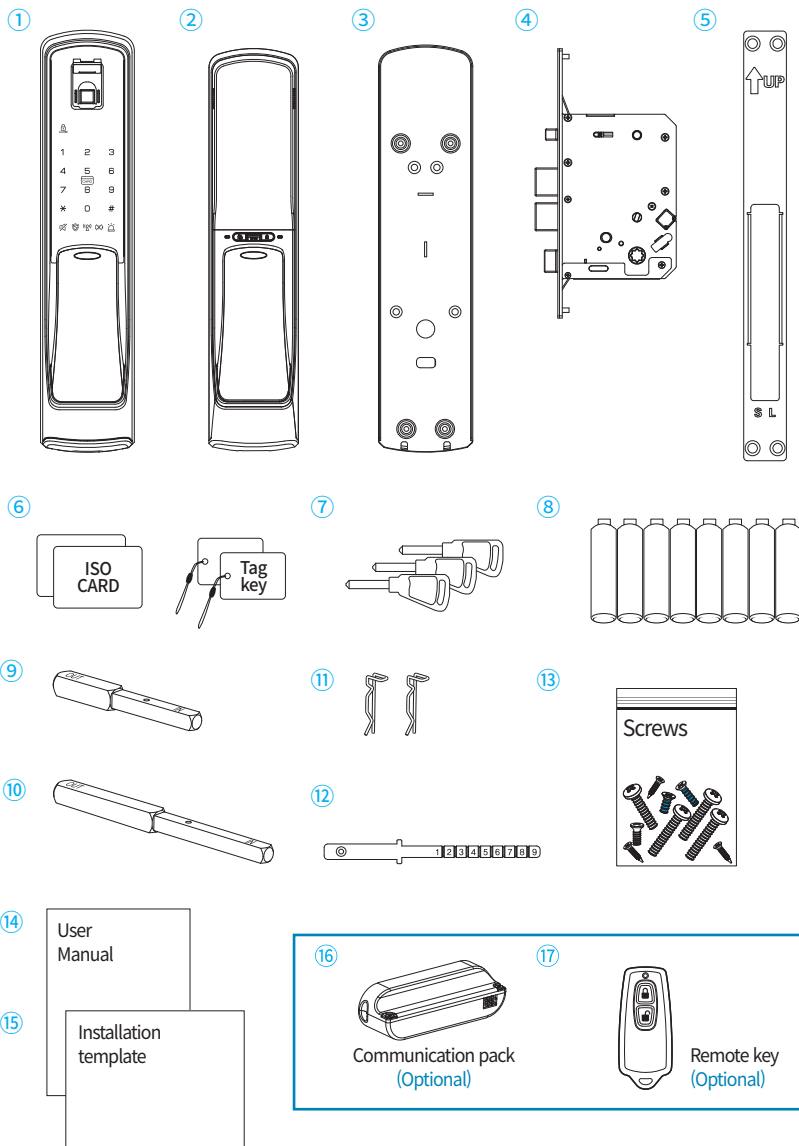

Name	Product specification	Remark
① Front Ass'y	88mm(W) X 396mm(H) X 40mm(D)	Including rubber pad
② Back Ass'y	83.7mm(W) X 373mm(H) X 38.7mm(D)	
③ Back Cover	88mm(W) X 381mm(H) X 8.7mm(D)	Including rubber pad
④ Mortise lock	105.4mm(W) X 240mm(H) X 24mm(D)	
⑤ Strike	24mm(W) X 240mm(H) X 4.5mm(D)	
⑥ Card key	ISO Card, Tag key	
⑦ Mechanical key	Mechanical key	
⑧ Battery	6V (1.5V 'AA' Size LR6 Alkaline, 8ea)	
⑨ Handle shaft	70.5mm(W) X 8mm(H) X 8mm(D)	40~50mm Door
⑩ Handle shaft(M)	101.7mm(W) X 8mm(H) X 8mm(D)	70~90mm Door
⑪ Handle shaft stop-ring	2ea	
⑫ Key tail plate	1ea	
⑬ Screws	1set	
⑭ User Manual	Main user manual	Including warranty form
⑮ Installation template	English, Chinese	
⑯ Communication Pack	Communication Pack	Optional
⑰ Remote key	Remote key	Optional
※ Door thickness	For 40~90mm	

Factory setting

Item	Setting status	Ref. page
Auto/Manual lock mode	[Auto-lock]	11
Language (English/Chinese)	English	11
Normal mode / Security mode	Normal mode	13
Voice guide volume (1~3 level)	3 level [Maximum]	15
Beep sound level (1~8 level)	8 level	15
Handle direction (Push/Pull)	Front cabinet - Pull / Back cabinet - Push	

Name and function of each part

1. Front ass'y

Finger print sensor

Touch the registered finger print on sensor, and then open the door

Status indicator

Indicate operation status and checking battery capacity.

Lock/Unlock lamp

Indicate lock/unlock status

Touch type numeric pad

Card key touch plate

Touch the registered card key to open the door.

Card key (ISO Card, Tag key)

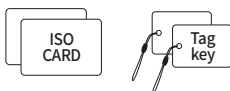

Mechanical key

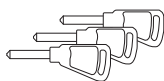

Window icon

- Mute function
- Safety handle
- Battery replacement indicator
- Trespass alarm function
- Wireless interlock

Handle

You can open the door by pushing or pulling it after pressing secret code, touching card key, or finger print.

Emergency Cover

Emergency Cover (External Emergency Power Supply Terminal & Emergency Key Insert Part)

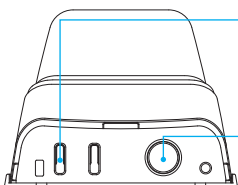

External Emergency Power Supply Terminal

When battery does not operate, product may be operated and unlocked by contacting 9V on terminal located outside.

Emergency Key Insert Part

Door may be opened through emergency key.

2. Back Ass'y

[N] button

Registration/Delete of code, card, finger print in normal mode

[S] button

Registration/Delete of code, card, finger print in safety mode

indicator lamp to set the safety handle

[Double lock function] button

Button to set double locking mode

🔍 Safety handle jog button

(Refer to the below explanation)

Handle

⚠️ Caution

In push handle type, please do not put your finger between handle and door lock body. Finger can be jammed or hurt when you try to open the door.

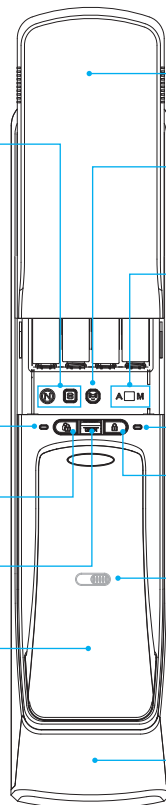

Battery cover

Push up to open the battery cover

[Option] button

To register or delete **optional RF communication module**

Auto/Manual mode switch

A : Auto mode
M : Manual mode

LED indicator (Locking status)

[Manual locking] button

Button to lock the door by manual at manual locking mode

Manual safety handle switch

To release safety handle function manually when Safety handle jog button is out of order or no battery

Cover

🔍 How to set the safety handle function



: When maintaining lower part [CLOSE] for 5 seconds

The safety handle function is set

















: When maintaining lower part [OPEN] for 3 seconds

The safety handle function is temporarily canceled.

⚠️ Caution : The safety handle function is a security function to prevent any physical intrusion from outside. Please use once method of use is familiar enough.

Description shortcut icons

 : [N] button	 : [S] button	 : [Option] button
 : Press [*]	 : Press [#]	 : Touch the front pad
 : Secret code	 : Card key	 : Finger print
 : User code	 : Manager code	 : Registration code
 : Trespass alarm	 : Unlock	 : Lock













※ Normal mode : [N] button / Safety mode : [S] button

How to replace battery



If battery lamp in RED is flickering with sound, separate battery cover, and replace all 8 batteries to new one, 6V(1.5V*AA' Size LR6 Alkaline)

How to apply external power in the emergency / How to use mechanical override key

External power in the emergency											
Secret code							Card key				
Mechanical override key											
Usage	Open the cover			Push or pull the handle and open the door							

How to use random security coding function

How to use random security coding function										
Usage			RAN DOM CODE							

How to unlock / to lock from outdoor

How to unlock from outdoor										
Secret code						Card key		Finger print		
How to unlock from outdoor (Mute function)										
Secret code										
Card key										
	3 ^{sec}	OFF								
	3 ^{sec}	OFF								
How to lock from outdoor										
Auto-locking mode										
Manual-locking mode										
How to set auto-locking/manual-locking										
Auto-locking mode		In Auto-locking mode , door will be locked automatically after closing.								
Manual-locking mode		In Manual-locking mode , door will be locked with pressing manual lock button after closing.								
How to select the language										
English				or						
Chinese				or						
	3 ^{sec}									
	3 ^{sec}									

How to unlock / to lock from indoor

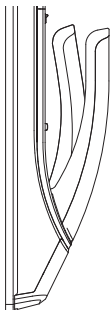

Please push the handle hard enough from indoor.

1. Auto-locking mode



When the door is closed, door is locked with beep sound automatically.

2. Manual-locking mode



Setting manual-mode



Press manual lock button, then door is locked

How to set double locking function

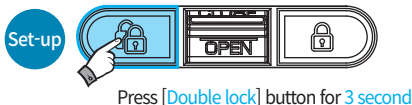

Safety Handle function

The safety handle function may be setup from both outside and inside, and is automatically canceled when the registered secret code or card is authorized from the outside. but from inside, only temporal cancel function is provided.

1. How to set the safety handle function from outdoor



2. How to set the safety handle function from indoor / How to release

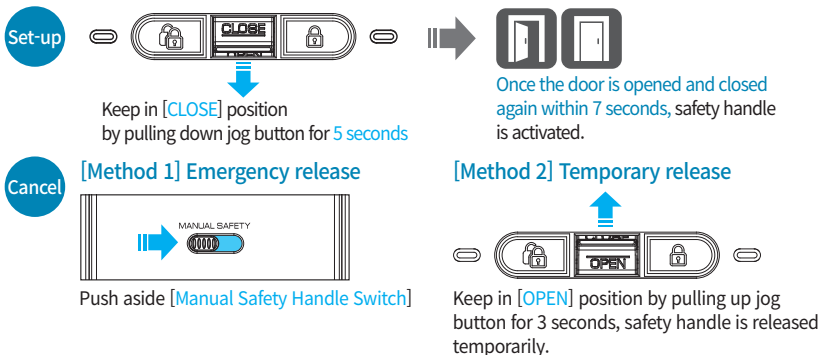

Auto-locking function / Auto-relocking function

1. Auto-locking function

When the door is closed, it will be locked automatically.



2. Auto-relocking function

If the door is not opened within 7 seconds after secret code, card key, finger print, it will be relocked automatically to protect user's property.

How to change normal mode / safety mode

- **Normal Mode** : Generally used mode, product released in normal mode.
- **Safety Mode** : High security mode with manager function added, provides individual register and delete function which is not provided in normal mode.

• Secret code : 10ea(6~12digits) / Card key : 20ea / Finger print : 100ea

N : [N] button **S** : [S] button **UC** : User code **MC** : Manager code
RC : Registration Code  : Card key  : Finger print

How to change from safety mode to normal mode









	1	2	3	4	5	6	7	8	9	10
Normal mode	 3 ^{sec}	MC	#	UC	#	UC	#			

How to change from normal mode to safety mode

Safety mode	 3 ^{sec}	UC	#	MC	#	MC	#			
-------------	--	-----------	----------	-----------	----------	-----------	----------	--	--	--

Normal mode

Normal mode













		1	2	3	4	5	6	7	8	9	10
REG.	Secret code		1	4	RC	*	...	*			
	Card key		1	5		...					
	Finger print		1	6		*					
DEL.	All Card key		2	5	*						
	All finger print		2	6	*						

※ Repeat Highlighted part for continuous register or delete

Safety mode

















· Secret code : 10ea(6~12digits) / Card key : 20ea / Finger print : 100ea

[N] : [N] button **[S]** : [S] button **[UC]** : User code **[MC]** : Manager code
[RC] : Registration Code  : Card key

Safety mode		1	2	3	4	5	6	7	8	9	10	11	12
REG.	Secret code	[S]	1	4	MC or 	#	RC	*	*				
	Card key	[S]	1	5	MC or 	#	Card Registration Number(2digits)		#		*		
	Finger print	[S]	1	6	MC or 	#	Finger print Registration Number(3 digits)			3 times	#	*	
DEL.	All card key	[S]	2	5	MC or 	#							
	Individual card key	[S]	3	5	MC or 	#	Card Registration Number(2digits)		#	*			
	All finger print	[S]	2	6	MC or 	#							
	Individual finger print	[S]	3	6	MC or 	#	Finger print Registration Number(3 digits)		#	*			
Safety mode (Manager)													
Change	Manager code	[S]	8	4	MC or 	#	RC	#	RC	#			
REG.	Manager card key	[S]	8	5	MC or 	#		*					
DEL.	All manager card key	[S]	8	6	MC or 	#	5						

※ Repeat Highlighted part for continuous register or delete

Additional function

How to control voice guide volume									
Min. volume								1	
Mid. volume		#	C or 	#	1			2	
Max. volume								3	
Guest secret code (Temporary use)									
REG.		#	C or 	#	2	RC	#	RC	#
How to control operation volume									
Vol. up		#	C or 	#	3			7	
Vol. down								9	
Status checking guide									
Voice guide		#	C or 	#	4				
Check battery capacity									
Voice guide		#	C or 	#	5				
Safety handle function									
Set up		#	C or 	#	8				
Warning function against mischief or hacking									
Operate	Wrong secret code 3 times or unregistered card key 3 times or unregistered finger print 5times								
Warning alarm function against trespassing by force									
Secret code		*	C	*					
Card key			C	*					

Communication pack /remote key Optional

1. How to install the communication pack

Communication pack

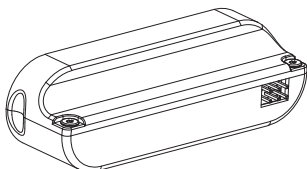

Portable remote key

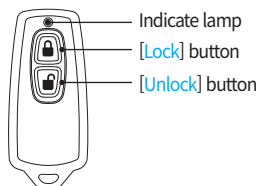

CR1620



When purchasing wireless communication pack and remote control package separately and equipping it, remote control may be used in conjunction.

- ※ One round battery(CR1620) is equipped.
- ※ To replace battery, open the back cover by screw driver.

Installing communication pack



1. Open the inner battery cover then remove the battery
2. Install the wireless communication pack on the connected terminal.
(Caution: Please fit the socket in the correct orientation)
3. Insert the batteries after confirming the direction of ⊖ and ⊕ .

2. How to register remote key & to unlock / to lock



: [Option] button



: Remote unlock



: Remote lock

To register / to delete remote key (Communication pack)

REG.	Remote key	3 ^{sec}	1	C or	#	🔒 or 🔓	✖	
DEL.	All remote key	3 ^{sec}	2	C or	#			

To lock / To unlock by remote key

Unlock	🔓		Lock	🔒			
--------	---	--	------	---	--	--	--

※ Repeat Highlighted part for continuous register or delete



SMART PUSH PULL DOORLOCK

MI-7800

中文说明书

▲ 注意

使用产品前请详细阅读本使用说明书。

客户必须接受销售单位或负责人填写的品质保证书，产品质量保证书必须准确填写，否则售后服务时会影响您的利益。本产品为近乎专用，如要安装在其他类型门时，与本公司要协商决定。

为了性能上的改善，有可能会随时更改本产品的功能与设计并不做预先通知。

安全注意



请勿擅自拆卸或随意改造本产品。擅自拆卸或改造会对产品造成损伤导致财产损失，有需要请产品的检修联系专业的售后服务公司和我公司客户服务中心。



若产品上有害气体泄露或喷发烟雾时请及时取下电池，否则会严重损害产品。



有害液体或气体泄漏。若产品外部接触高湿度环境，请及时用柔软的抹布擦拭干净若发现内部有进水或其他液体进入时，请立即卸下电池。



定期情节和检查。建议每6个月进行电池电量及漏液检查，并清洁电池连接处的接触弹簧，如果发现漏液现象，请立即卸下电池，用干布擦拭漏液液体，并更换新的电池，并在处理完毕后立即用香皂洗手。



禁止使用易燃物质擦拭产品，比如含有酒精或苯类成分的物质。使用此物质会损坏本产品的外观，或带来火灾隐患



电池不可以暴露在高温环境中，或靠近火源的地方。此类环境会导致电池漏液，并有爆炸危险。请选用质量合格的电池。



电池电极部位不要与钥匙链或金属物解除。这可能会导电电池过热引发爆炸。



请勿在方舌伸出的状态下关门。这样会损坏锁体，导致锁体无法工作



不要猛烈拍打触控面板。这样容易损坏外面板，可能导致故障。



请勿混用新旧电池。混用新旧电池会影响电池的使用寿命，及发生漏液和过热现象，造成安全隐患



请勿将物品悬挂在把手上。这样将容易产品的故障。

产品特色



现场拉把手换向简便

按照开门的方向，现场推拉把手换向简单及方便。



安心外出模式

室内机把手设计，可有效防止强行非法进入



锁体现场换向方便

本锁芯可以左右向调整，安装时非常方便。



自动上锁/手动上锁切换简便

室内机的[自动/手动]上锁开关，方便切换



自动反锁功能

用密码，感应卡或者指纹开锁后，但门未打开时，将自动重新上锁，保护财产安全。



双重上锁

如果在屋内设置为双重上锁功能，在屋外用密码，感应卡或者指纹无法打开门锁。夜间更安心（只有使用钥匙可以开锁）



静音功能

在使用产品时可以随时使用静音功能，以避免开门时打扰其他人。



更换电池提示功能

产品在使用中发生低电量情况时，会以警报音和灯光闪烁进行提示。



非法侵入警报功能

如果门处于异常开锁状态，将发出警报音。



防骚扰及防密码破解警报功能

连续输错密码，感应卡，指纹时，将启动防骚扰及防密码破解警报功能并发出警报音，同时在一定的时间范围内，功能运作将停止。



具有虚位密码功能

与他人同行入户时，先任意按下几个数字(虚位密码)，然后输入正确密码开锁。

采用这种无限虚位密码功能系统，更进一步强化了保护密码的功能。



一般模式/管理模式

一般模式：提供更加便利

管理模式：提供更多管理功能



[选项]键

1. 设定/删除无线模块

2. 选择语言

产品构造及组成产品介绍

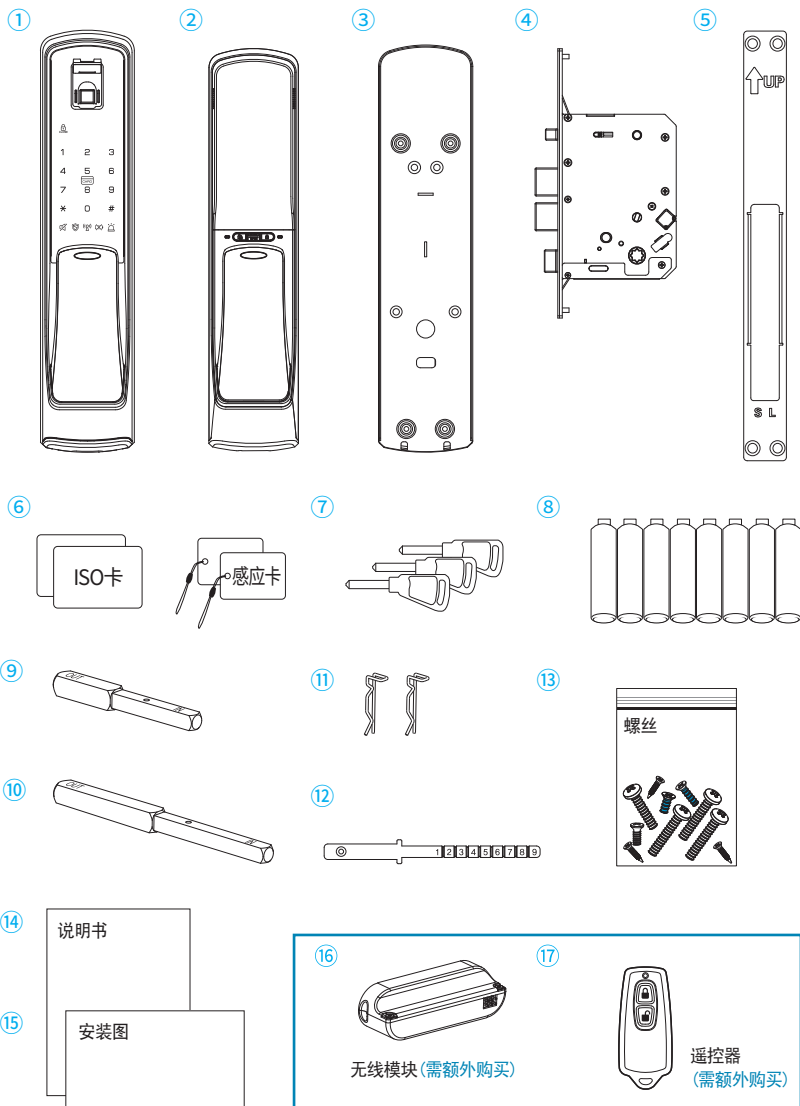

名称	尺寸	备注
① 室外机	88mm(W) X 396mm(H) X 40mm(D)	包含室外机橡胶垫片
② 室内机	83.7mm(W) X 373mm(H) X 38.7mm(D)	
③ 室内机罩盖	88mm(W) X 381mm(H) X 8.7mm(D)	包含室外机橡胶垫片
④ 锁体	105.4mm(W) X 240mm(H) X 24mm(D)	
⑤ 锁扣板	24mm(W) X 240mm(H) X 4.5mm(D)	
⑥ 感应卡	ISO卡, 感应卡	
⑦ 钥匙	钥匙	
⑧ 电池	6V (1.5V 'AA' Size LR6 Alkaline, 5号电池8节)	
⑨ 方棒	70.5mm(W) X 8mm(H) X 8mm(D)	40~50 mm 防盗门
⑩ 方棒(M)	101.7mm(W) X 8mm(H) X 8mm(D)	70~90 mm 防盗门
⑪ 方棒弹簧	2个	
⑫ 钥匙柄	1张	
⑬ 螺丝	1套	
⑭ 安装图	安装图	
⑮ 说明书	英文, 中文	含产品品质保证书
⑯ 无线模块	需额外购买	需额外购买
⑰ 遥控器	遥控器	需额外购买
※ 安装条件	门厚度: 40~90mm	

原厂设置为状态

功能	设置状态	参考页
自动上锁/手动上锁	[自动上锁]	27
选择语言(英文/中文)	英文	27
一般模式/管理模式	一般模式	29
语音音量(1~3阶段)	3阶段 [最大]	31
操作音(1~8阶段)	8阶段	31
室外机/室内机把手方向	室外机把手(拉)/ 室内机把手(推)	

部件的名称及功能

1. 室外机

指纹感应区

接触已设定的指纹，
可以开锁

[上锁/开锁] 指示灯

表示产品的[上锁/开锁]状态。

触摸式数字键盘

输入密码开锁或设定密码

感应卡 (大/小)

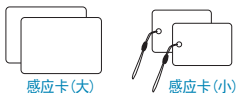

钥匙

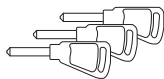

钥匙盖子

状态指示灯

通过指示灯反映操作状态及确认
电池用量

感应卡接触区

接触已设定的感应卡开锁
或设定感应卡

窗口图标

- 静音 指示灯
- 安心外出模式指示灯
- 电池指示灯
- 紧急警报指示灯
- 无线模块指示灯

室外机把手

用密码，感应卡，指纹开锁
后，拉或推把手，可以开门。

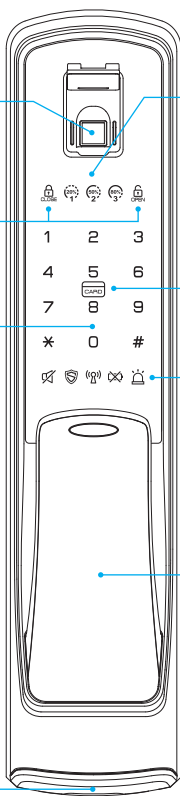

钥匙盖子 (外部应急电源接口/钥匙)

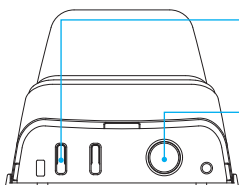

外部应急电源接口

电池电量耗尽时在外面使用9V方形电池接触此接口可以临时供电，可以让产品重新工作。

钥匙

使用钥匙手动开锁。

2. 室内机

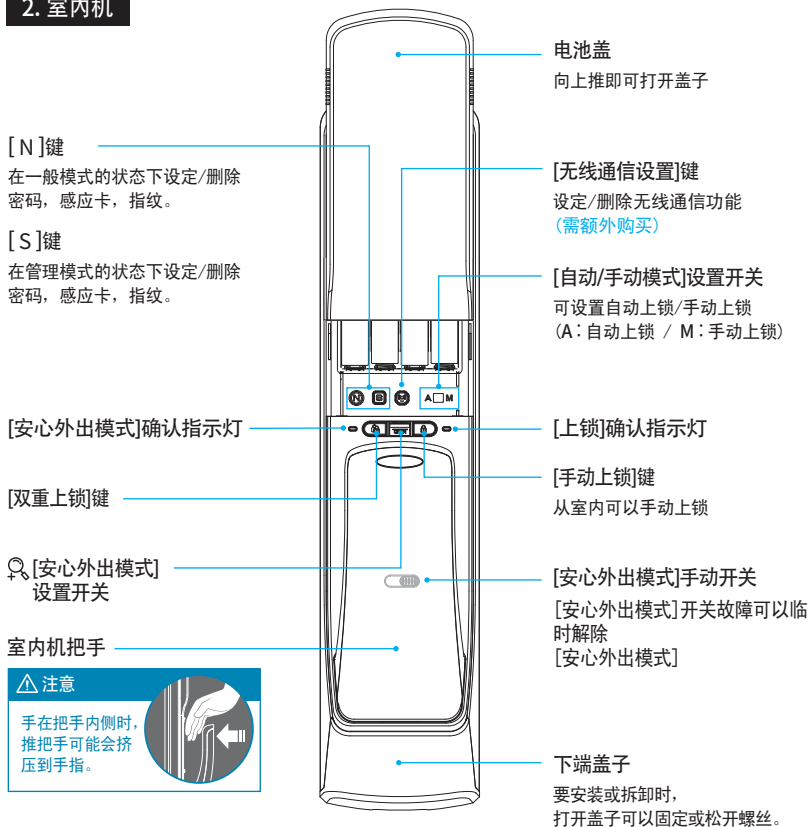

🔍 [安心外出模式]设置办法



: 用[安心外出模式]开关, 下压
[CLOSE]方向维持五秒, 即设置完成

⚠️ **注意:** 安心外出模式是防止强行非法进入。请仔细阅读使用说明后使用。
(请参考安心外出模式12页)



: 用[安心外出模式]开关, 下压
[OPEN]方向维持三秒,
即临时解除完成。

快捷图标介绍

 : [N]键	 : [S]键	 : [选项]键
 : 按[*]键	 : 按[#]键	 : 接触触控面板
 : 密码	 : 感应卡	 : 指纹
 : 用户密码	 : 管理者密码	 : 新密码
 : 开锁	 : 上锁	 : 非法侵入警 功能

※ 一般模式:[N]键 / 管理模式:[S]键

更换电池



电池标志灯闪烁，同时发出电池更换警告音。
把室内机上的电池盖沿着箭头方向拉开。
：请确认电池方向，6V(5号电池8节)

外部应急电源及钥匙使用办法

外部应急电源											
密码							感应卡				
钥匙											
使用	把室外机的下端盖子拉				拉或拉把手，即开门						

虚位密码功能

虚位密码功能										
使用			虚位功能							

从外部开锁/上锁

从外部开锁										
密码						感应卡		指纹		
从外部开锁 (静音功能)										
密码	3 ^{sec}	OFF								
感应卡	3 ^{sec}	OFF								
从外部上锁 (自动上锁/手动上锁)										
自动上锁										
手动上锁										
自动上锁/手动上锁										
自动上锁		设置[自动上锁]，在关门时，会自动上锁。								
手动上锁		设置[手动上锁]。即使关门也不会上锁。								
选择语言										
英文	3 ^{sec}		或							
中文	3 ^{sec}		或							

从内部开锁/上锁

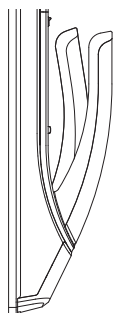

充分地推把手

1. [自动上锁]模式



如果在[自动上锁]设置下关门时，发出(-吡哩哩)音，即自动上锁

2. [手动上锁]模式



设置[手动模式]



按[手动上锁]键，即上锁

双重上锁功能



安心外出模式

安心外出模式是用户从外部和内部均可以设置，用已设定的密码或卡从外部正常开锁后，安心外出模式自动解除。但如果用户设置这个功能后，从内部开锁的话临时解除功能。

1. 从外部设置/解除安心外出模式



2. 从内部设置/解除安心外出模式

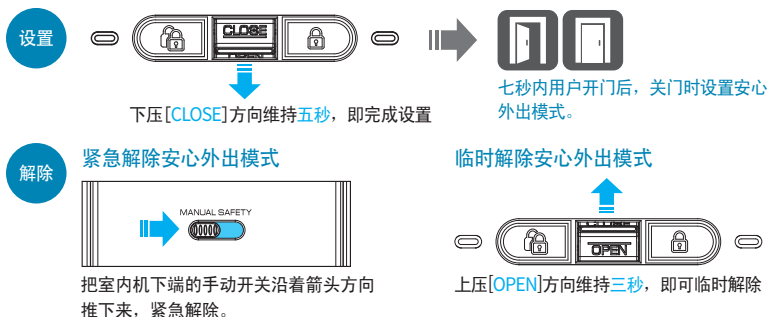

自动上锁功能/自动反锁功能

1. 自动上锁功能

是指关门后门锁将会自动上锁的功能

2. 自动反锁功能





用密码、感应卡与指纹开锁后，七秒内不开门时将自动上锁保护顾客的财产。

切换一般模式/管理模式



























- 一般模式：提供更便利，原厂设置为一般模式。
- 管理模式：提供更多管理功能

· 密码：10组(4~12位数) / 感应卡：20张 / 指纹：100张

 : [N] 键
  : [S] 键
  : 用户密码
  : 管理者密码
 : 新密码
  : 感应卡
  : 指纹

管理模式切换到一般模式										
	1	2	3	4	5	6	7	8	9	10
一般模式										
一般模式切换到管理模式										
管理模式										

一般模式























一般模式											
		1	2	3	4	5	6	7	8	9	10
设定	密码										
	感应卡										
	指纹										
删除	全部感应卡										
	全部指纹										

※ 阴影部分是重复设定或者删除

管理模式

· 密码：10组(4~12位数) / 感应卡：20张 / 指纹：100张

 : [N] 键
  : [S] 键
  : 用户密码
  : 管理者密码
 : 新密码
  : 感应卡
  : 指纹

管理模式		1	2	3	4	5	6	7	8	9	10	11	12
设定	密码		1	4	MC 或 	#	RC	*	*				
	感应卡		1	5	MC 或 	#	输入两位数要登记的感应卡号码			#		*	
	指纹		1	6	MC 或 	#	输入三位数要登记的指纹号码				三次	#	*
删除	全部感应卡		2	5	MC 或 	#							
	单独感应卡		3	5	MC 或 	#	输入两位数要登记的感应卡号			#	*		
	全部指纹		2	6	MC 或 	#							
	单独指纹		3	6	MC 或 	#	输入三位数要登记的指纹号码			#	*		
管理模式(管理者)													
变更	管理者密码		8	4	MC 或 	#	RC	#	RC	#			
设定	管理者感应卡		8	5	MC 或 	#		*					
删除	全部管理者感应卡		8	6	MC 或 	#	5						

※ 阴影部分是重复设定或者删除

介绍附加功能

调整语音音量										
最少								1		
中等		#	C	或		#	1	2		
最大								3		
设定一次性密码										
设定		#	C	或		#	2	RC	#	RC #
调整操作音量										
音量加大								7		
音量减少		#	C	或		#	3	9		
确认设置的情况										
语音		#	C	或		#	4			
确认电池用量										
语音		#	C	或		#	5			
安心外出模式										
设定		#	C	或		#	8			
防骚扰及防密码破解警报功能										
动作								输错三次或读错三次或读错5次		
非法侵入警报功能										
密码		*	C	*						
感应卡			C	*						

无线模块/遥控器 另外购买

1. 无线模块

无线模块

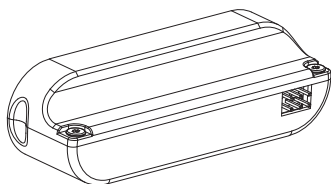

遥控器

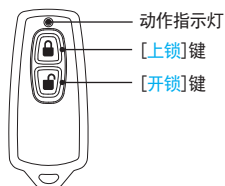

动作指示灯

[上锁]键

[开锁]键

CR1620



※ 内装有纽扣电池 (CR1620)

※ 解开螺丝钉即可更换新电池

安装无线模块

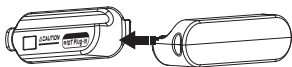

1. 打开电池盖后拆下所有的电池
2. 把无线模块安装在无线模块连接部
3. 确认 (⊖, ⊕) 方向, 再放入全部电池

2. 设定遥控器(无线模块)及开锁



: [无线模块] 键



: 开锁



: 上锁

设定/删除遥控器 (无线模块)

设定	遥控器	3"sec	1	C 或	#	或	*	
删除	全部遥控器	3"sec	2	C 或	#			

用遥控器开锁/开门

开锁			开门					
----	--	--	----	--	--	--	--	--

※ 阴影部分是重复设定或者删除

安全注意



請勿擅自拆卸或隨意改造本產品。擅自拆卸或改造會對產品造成損傷導致財產損失，有需要請產品的檢修聯系專業的售後服務公司和我公司客戶服務中心。



若產品上有害氣體泄露或噴發煙霧時請及時取下電池，否則會嚴重損害產品。



有害液體或氣體泄漏。若產品外部接觸高濕度環境，請及時用柔軟的抹布擦拭乾淨若發現內部有進水或其他液體進入時，請立即卸下電池。



定期情節和檢查。建議每6個月進行電池電量及漏液檢查，並清潔電池連接處的接觸彈簧，如果發現有漏液現象，請立即卸下電池，用幹布擦拭泄漏，並更換新的電池，並在處理完畢後立即用香皂洗手。



禁止使用易燃物質擦拭產品，比如含有酒精或苯類成分的物质。使用此物質會損壞本產品的外觀，或帶來火災隱患



電池不可以暴露在高溫環境中，或靠近火源的地方。此類環境會導致電池漏液，並有爆炸危險。請選用質量合格的電池。



電池電極部位不要與鑰匙鏈或金屬物解除。這可能會導電池過熱引發爆炸。



請勿在方舌伸出的狀態下關門。這樣會損壞鎖體，導致鎖體無法工作



不要猛烈拍打觸控面板。這樣容易損壞外面板，可能導致故障。



請勿混用新舊電池。混用新舊電池會影響電池的使用壽命，及發生漏液和過熱現象，造成安全隱患



請勿將物品懸挂在把手上。這樣將容易產品的故障。

產品特色



現場提拉把手換向簡便

按照開門的方向，現場推拉把手換向簡單及方便。



安心外出模式

室內機把手設計，可有效防止強行非法進入



鎖體現場換向方便

本鎖芯可以左右向調整，安裝時非常方便。



自動上鎖/手動上鎖切換簡便

室內機的[自動/手動]上鎖開關，方便切換



自動反鎖功能

用密碼，感應卡或者指紋開鎖後，但門未打開時，將自動重新上鎖，保護財產安全。



雙重上鎖

如果在屋內設置為雙重上鎖功能，在屋外用密碼，感應卡或者指紋無法打開門鎖。夜間更安心（只有使用鑰匙可以開鎖）



靜音功能

在使用產品時可以隨時使用靜音功能，以避免開門時打擾其他人。



更換電池提示功能

產品在使用中發生低電量情況時，會以警報音和燈光閃爍進行提示。



非法侵入警報功能

如果門處於異常開鎖狀態，將發出警報音。



防騷擾及防密碼破解警報功能

連續輸錯密碼，感應卡，指紋時，將啓動防騷擾及防密碼破解警報功能並發出警報音，同時在一定的時間範圍內，功能運作將停止。



具有虛位密碼功能

與他人同行入戶時，先任意按下幾個數字(虛位密碼)，然後輸入正確密碼開鎖。

採用這種無限虛位密碼功能系統，更進一步強化了保護密碼的功能。



一般模式/管理模式

一般模式：提供更加便利

管理模式：提供更多管理功能



[選項]鍵

1. 設定/刪除無線模塊
2. 選擇語言

產品部件及構成品介紹

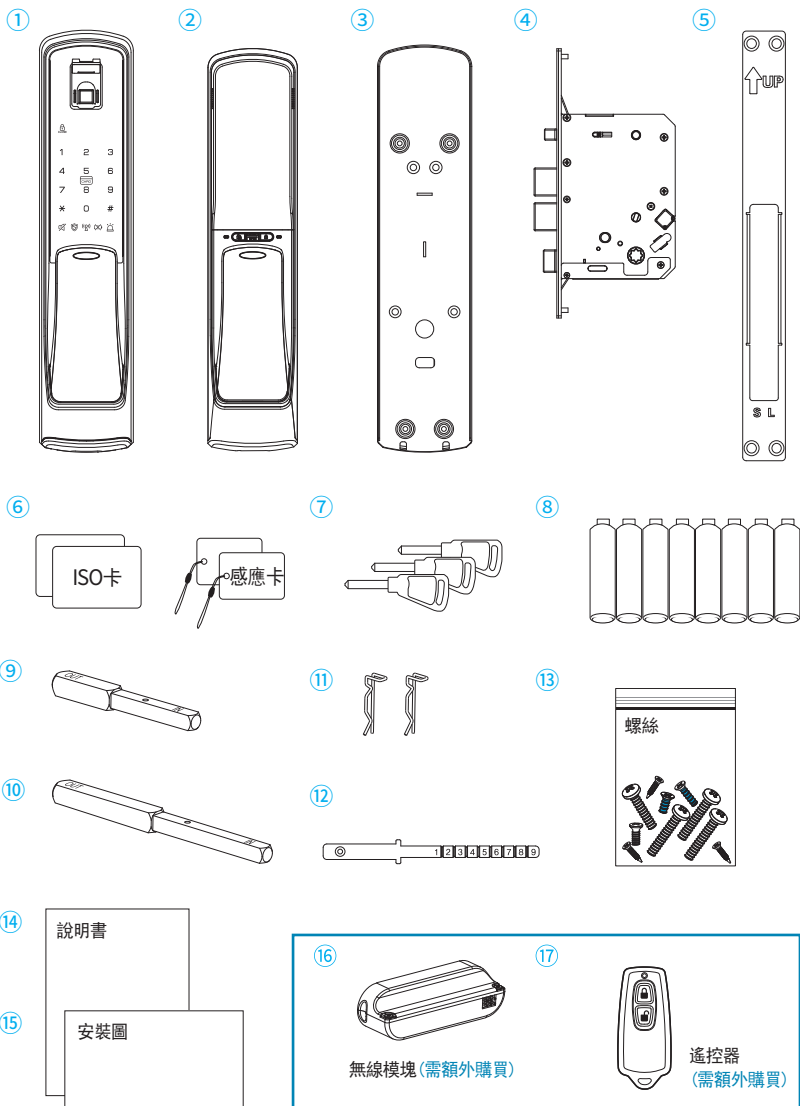

名称	尺寸	備註
① 室外機	88mm(W) X 396mm(H) X 40mm(D)	包含室外機橡膠墊片
② 室內機	83.7mm(W) X 373mm(H) X 38.7mm(D)	
③ 室內機罩蓋	88mm(W) X 381mm(H) X 8.7mm(D)	包含室外機橡膠墊片
④ 鎖體	105.4mm(W) X 240mm(H) X 24mm(D)	
⑤ 鎖扣板	24mm(W) X 240mm(H) X 4.5mm(D)	
⑥ 感應卡	ISO卡，感應卡	
⑦ 鑰匙	鑰匙	
⑧ 電池	6V (1.5V 'AA' Size LR6 Alkaline, 5号電池8節)	
⑨ 方棒	70.5mm(W) X 8mm(H) X 8mm(D)	40~50 mm 防盜門
⑩ 方棒(M)	101.7mm(W) X 8mm(H) X 8mm(D)	70~90 mm 防盜門
⑪ 方棒彈簧	2個	
⑫ 鑰匙柄	1張	
⑬ 螺絲	1套	
⑭ 安裝圖	安裝圖	
⑮ 說明書	英文，中文	含產品品質保證書
⑯ 無線模塊	無線模塊	需額外購買
⑰ 遙控器	遙控器	需額外購買
※ 安裝條件	門厚度：40~90mm	

原廠設置為狀態

功能	設置狀態	參考頁
自動上鎖/手動上鎖	[自動上鎖]	41
選擇語言(英文/中文)	英文	41
一般模式/管理模式	一般模式	43
語音音量(1~3階段)	三階段 [最大]	45
操作音 (1~8階段)	八階段	45
室外機/室內機手把方向	室外機把手(拉)/室內機把手(推)	

部件的名稱及功能

1. 室外機

指紋感應區

接觸已設定的指紋，
可以開鎖

[上鎖/開鎖]指示燈

表示產品的[上鎖/開鎖]狀態。

觸摸式數字鍵盤

輸入密碼開鎖或設定密碼

感應卡 (大/小)

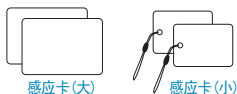

鑰匙

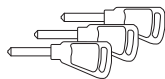

鑰匙蓋子

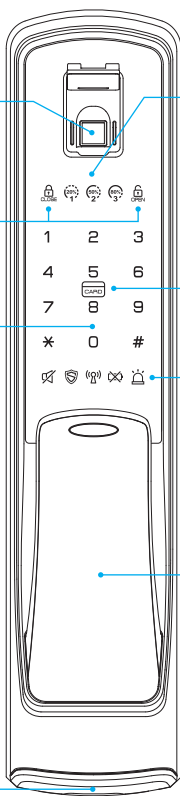





狀態指示燈

通過指示燈反映操作狀態及確認
電池用量

感應卡接觸區

接觸已設定的感應卡開鎖或設
定感應卡時，可以使用

窗口圖標

-  靜音指示燈
-  安心外出模式指示燈
-  電池指示燈
-  緊急警報指示燈
-  無線模塊指示燈

室外機把手

用密碼，感應卡，指紋開鎖
後，拉或推把手，可以開門。

鑰匙蓋子(外部應急電源接口/鑰匙)

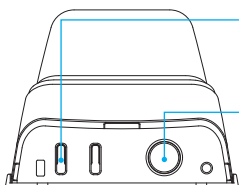

外部應急電源接口

電池電量耗盡時在外面使用9V方形接觸此接口可以臨時
供电，可以讓產品重新工作。

鑰匙

使用鑰匙手動開鎖。

2. 室内机

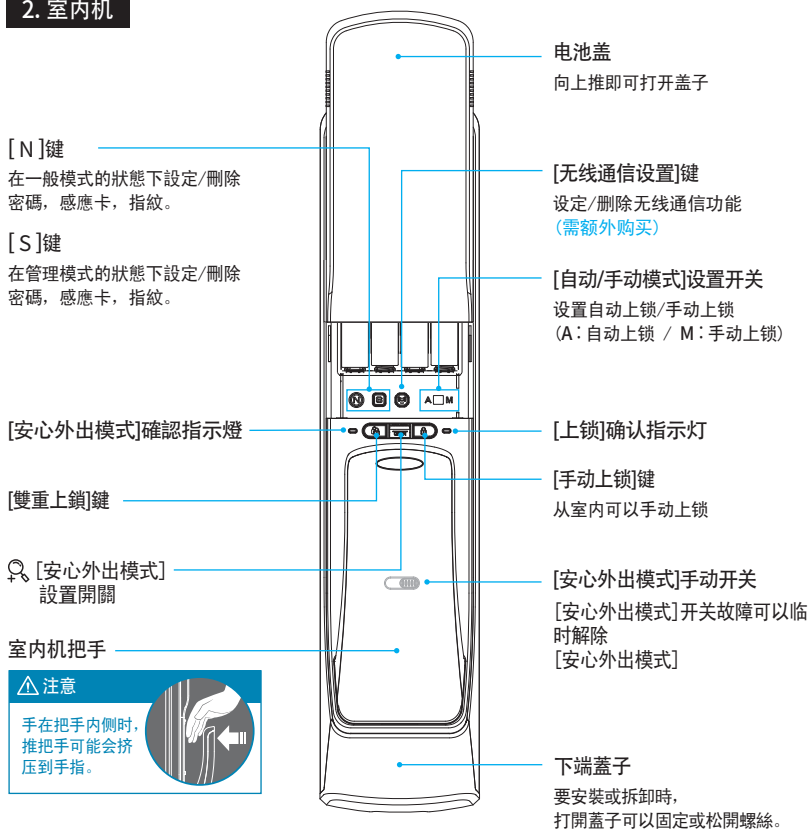

🔍 [安心外出模式]設置辦法



: 用 [安心外出模式] 開關, 下壓 [CLOSE] 方向維持五秒, 即設置完成

△ 注意: 安心外出模式是防止強行非法進入。請仔細閱讀使用說明後使用。
(請參考安心外出模式12頁)



: 用 [安心外出模式] 開關, 下壓 [OPEN] 方向維持三秒, 即臨時解除完成

快捷圖標介紹

 : [N] 鍵	 : [S] 鍵	 : [選項] 鍵
 : 按[*] 鍵	 : 按[#] 鍵	 : 接觸控制面板
 : 密碼	 : 感應卡	 : 指紋
 : 用戶密碼	 : 管理者密碼	 : 新密碼
 : 開鎖	 : 上鎖	 : 非法侵入警報功能

※ 一般模式: [N] 鍵/管理模式: [S] 鍵

更換電池



電池標志燈閃爍，同時發出電池更換警告音。
把室內機上的電池蓋沿著箭頭方向拉開。
：請確認電池方向，6V(5號電池8節)

外部應急電源及鑰匙使用辦法

外部應急電源												
密碼							感應卡					
鑰匙												
使用	把室外機的下端蓋子拉				拉或拉把手，即開門							

虛位密碼功能

虛位密碼功能										
使用			虛位密碼							

從外部開鎖/上鎖

從外部開鎖									
密碼						感應卡		指紋	
從外部開鎖 (靜音功能)									
密碼	3 ^{sec}	OFF							
感應卡	3 ^{sec}	OFF							
從外部上鎖 (自動上鎖/手動上鎖)									
自動上鎖									
手動上鎖									
設置[自動/手動]上鎖功能									
自動上鎖		設置[自動上鎖]，在關門時，會自動上鎖。							
手動上鎖		設置[手動上鎖]。即使關門也不會上鎖。							
選擇語言									
英文	3 ^{sec}		或						
中文	3 ^{sec}		或						

從內部開鎖/上鎖

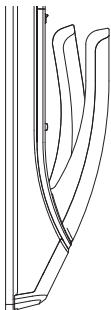

充分地推把手

1. [自動上鎖]模式



如果在[自動上鎖]設置下關門時，發出(~吡哩哩)音，即自動上鎖

2. [手動上鎖]模式



設置[手動模式]



按[手動上鎖]鍵，即上鎖

雙重上鎖功能



安心外出模式

安心外出模式是用戶從外部和內部均可以設置，用已設定的密碼或卡從外部正常開鎖後，安心外出模式自動解除。但如果用戶設置這個功能後，從內部開鎖的話臨時解除功能。

1. 從外部設置/解除安心外出模式



2. 從內部設置/解除安心外出模式

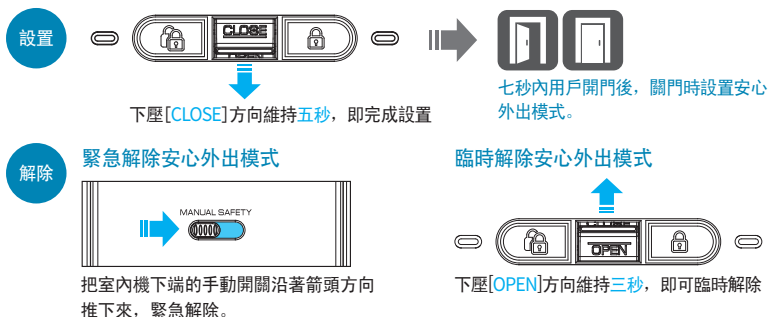

自動上鎖功能/自動反鎖功能

1. 自動上鎖功能

是指關門後門鎖將會自動上鎖的功能

2. 自動反鎖功能

用密碼、感應卡與指紋開鎖後，七秒內不開門時將自動上鎖保護顧客的財產。







切換一般模式/管理模式

- 一般模式：提供更便利，原厂設置為一般模式。
- 管理模式：提供更多管理功能

· 密碼：10組(4~12位數) / 感應卡：20張 / 指紋：100張

 : [N] 鍵
  : [S] 鍵
  : 用戶密碼
  : 管理者密碼
 : 新密碼
  : 感應卡
  : 指紋

管理模式切換到一般模式

























	1	2	3	4	5	6	7	8	9	10
一般模式	 3 ^{sec}									

一般模式切換到管理模式

管理模式	 3 ^{sec}									
------	--	---	---	---	---	---	---	--	--	--

一般模式

一般模式























		1	2	3	4	5	6	7	8	9	10
設定	密碼						...				
	感應卡					...					
	指紋										
刪除	全部感應卡										
	全部指紋										

※ 陰影部分是重複設定或者刪除

管理模式

· 密碼：10組(4~12位數) / 感應卡：20張 / 指紋：100張

 : [N] 鍵
  : [S] 鍵
  : 用戶密碼
  : 管理者密碼
 : 新密碼
  : 感應卡
  : 指紋

管理模式		1	2	3	4	5	6	7	8	9	10	11	12
設定	密碼		1	4	MC 或 	#	RC	*	*				
	感應卡		1	5	MC 或 	#	輸入兩位數要登記的感應卡號碼			#		*	
	指紋		1	6	MC 或 	#	輸入三位數要登記的指紋號碼				三次	#	*
刪除	單獨感應卡		2	5	MC 或 	#							
	單獨感應卡		3	5	MC 或 	#	輸入兩位數要登記的感應卡號碼			#	*		
	單獨指紋		2	6	MC 或 	#							
	單獨指紋		3	6	MC 或 	#	輸入三位數要登記的指紋號碼			#	*		
管理模式(管理者)													
變更	管理者密碼		8	4	MC 或 	#	RC	#	RC	#			
設定	管理者感應卡		8	5	MC 或 	#		*					
刪除	全部管理者感應卡		8	6	MC 或 	#	5						

※ 阴影部分是重复设定或者删除

附加功能

調整語音音量									
最少								1	
中等		#	C	或		#	1	2	
最大								3	
設定一次性密碼									
設定		#	C	或		#	2	RC	# RC #
調整操作音量									
音量加大								7	
音量減少		#	C	或		#	3	9	
確認設置的情況									
語音		#	C	或		#	4		
確認電池用量									
語音		#	C	或		#	5		
安心外出模式									
設定		#	C	或		#	8		
防騷擾及防密碼破解警報功能									
動作									
非法侵入警報功能									
密碼		*	C	*					
感應卡			C	*					

無線模塊/遙控器 另外購買

1. 安裝無線模塊

無線模塊

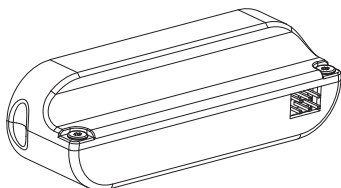

遙控器

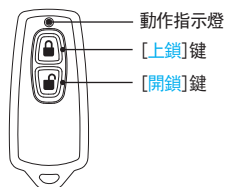

CR1620



- ※ 內裝有鈕扣電池 (CR1620)
- ※ 解開螺絲釘即可更換新電池

安裝無線模塊



1. 打開電池蓋後拆下所有的電池
2. 把無線模塊安裝在無線模塊連接部
3. 確認 (⊖, ⊕) 方向, 再放入全部電池

2. 設定遙控器(無線模塊)及開鎖

: [選項] 鍵
 : 開鎖
 : 上鎖

設定/刪除遙控器 (無線模塊)

設定	遙控器	3 ^{sec}	1	C 或	#	或	* (shaded)		
刪除	全部遙控器	3 ^{sec}	2	C 或	#				

用遙控器開鎖/開門

開鎖			開鎖						
----	--	--	----	--	--	--	--	--	--

※ 阴影部分是重复设定或者删除

Product Warranty

⊗ The warranty period shall be one year from the date of installation.

(for agency)

Model		Serial No		Purchase Date
Customer		Address			
Phone					
Agency		Installer		Phone	

- ⊗ Please keep this warranty for your after-sales service. You may have to pay for the service if you fail to present the warranty.
- ⊗ Failure to fill out form fields such as purchase date may void warranty.
- ⊗ The product may not be regarded as genuine, if no serial number is described on the warranty.

產品品質保證書

⊗ 產品保證期為自安裝日起一年。

(銷售單位填寫)

型號		編號		安裝日期 (購買日期)
顧客姓名		地址			
電話					
銷售單位		負責人		電話	

- ⊗ 請妥善保管產品質量保證書。
- ⊗ 在售後服務時，必須出事產品質量保證書，後則按投資費維修處理。
- ⊗ 如無產品編號，視為非正品，因此按自費維修處理。



Rev 0.0

Scans the product QR code to
View Detailed Device Information.